

PANMINQUARTZ PRODUCT MANUAL

PANMINQUARTZ®

PANMIN

Corporate Headquarters:

RM 2002, No.21 Jiahe Rd, Xiamen City, Fujian Province, China

China Factories:

Kuixia Industrial Area, Shijing Town, Nan'an City, Fujian Province, China

No.58 Zhengxing Ave, Zhangzhou City, Fujian Province, China

Cambodia Factory:

ZSEZ, KM175, No.4 National Rd, Prey Nob, Sihanouk Province, Cambodia

Introduction

PANMIN is a comprehensive and innovative supplier of both natural and man-made stone products. PANMINQUARTZ® is man-made quartz surfaces from PANMIN, which can be applied for residential and commercial interior decoration including kitchen countertops, bathroom vanities, office tables, wall panels, tiles, and more. Fabricators process countertops and other products from slabs purchased from PANMIN. PANMIN provides a Residential 15 Years Warranty and Commercial 10 Years Limited Warranty to the end-users purchasing countertops from certified fabricators regarding the quality of slab. Any failure by a Fabricator to comply with the recommended methods of fabrication of countertops from slabs may result in the refusal of an end-user claim.

PANMIN has its main office and two factories in China, and one factory in Cambodia. Our globalization setup will benefit our customers from different locations and areas.

PANMIN has acquired products certification such as SGS, NSF and UL since 2012. PANMINQUARTZ® is CE certificated and is evaluated and certified by NSF. It also has Greenguard Gold certified by UL for low chemical emissions, guaranteeing safety factors to sensitive individuals such as children and the elderly, patients in schools and hospitals. The certification ensures the final consumer's maximum safety and protection.

PANMINQUARTZ® has been keeping high quality. It not only meets the international certification standards but also customers' satisfaction. We are devoted to providing sufficient services to our customers. As long as you need, don't hesitate to contact us.

NOTE:

No parts of this work may be reproduced in any form or by any means – graphic, electronic, or mechanical, including photocopying, recording, taping, or information storage and retrieval systems without the written permission of PANMIN.

Products that are referred to in this document may be either trademarks and/or registered trademarks of the respective owners. The publisher and the author do not claim to these trademarks.

PANMIN and /or its assignees are not responsible for errors or omissions, or damages resulting from the use of information contained in this document. This manual does not replace normal industry standards for the professional stone fabrication. In no event shall the publisher and the author be liable for any loss of profit or any other commercial damage caused or alleged to have been caused directly or indirectly as a result of any person relying upon any information contained in this document. All work carried out by any user of this manual on any PANMINQUARTZ slab must be done in accordance with all laws and regulations relating to that work and the slab, including but not limited to, occupational health and safety laws and laws relating to the protection of the environment.

NOTE: This manual is not for general distribution.

This manual supersedes all previous manuals. Content is subject to change at any time without notice. The use of the term “Distributor” and “we” throughout this document refers to PANMIN. PANMINQUARTZ ® is the registered trademark of Xiamen Deyuan Panmin Trading Co., Ltd.

PANMINQUARTZ Product Manual

© 2021 Xiamen Deyuan Panmin Trading Co., Ltd., Inc. All rights reserved.

CONTENTS:

Basic Information

04

Guideline for Respirable Crystalline Silica Health Hazards & Protection

09

Fabrication Instructions

14

Installation Instructions

21

Care and Maintenance

27

Residential Lifetime Warranty & Commercial Limited Warranty

31

Material Safety Data Sheet

41

Receipt Form

55

BASIC INFORMATION

Applications

PANMIN is a comprehensive and innovative supplier of both natural and man-made stone products for interior commercial and residential applications. PANMINQUARTZ is man-made quartz surfaces from PANMIN, which can be applied in residential and commercial interior decoration including kitchen countertops, bathroom vanities, office tables, wall panels, tiles, and more.

PANMINQUARTZ is not suitable for outdoor use, or excessive heat over 300° F, or any exposure to direct ultraviolet radiation.

Measurement

PANMINQUARTZ is available in sizes as listed below:

Quartz Size

MEGA

Quartz nominal slab size: 138" (3500 MM) * 79" (2000 MM)

Quartz real slab size: 139" (3530 MM) * 80" (2030 MM)

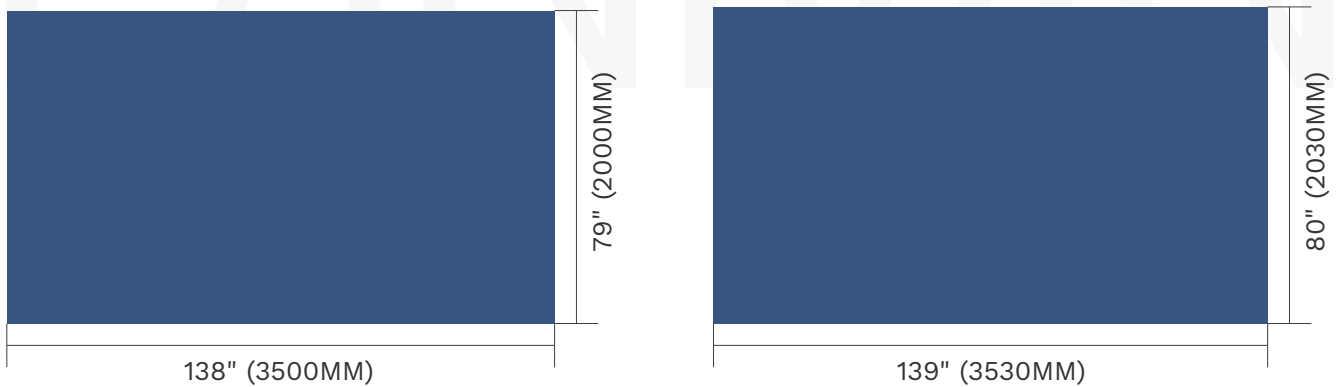

JUMBO

Quartz nominal slab size: 126" (3200 MM) * 63" (1600 MM)

Quartz real slab size: 127" (3230 MM) * 64" (1630 MM)

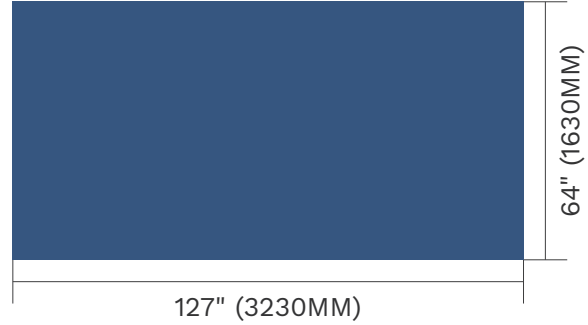
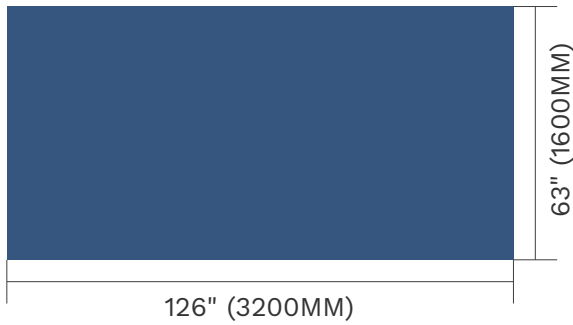

STD

Quartz nominal slab size: 118" (3000 MM) * 55" (1400 MM)

Quartz real slab size: 119" (3030 MM) * 56" (1430 MM)

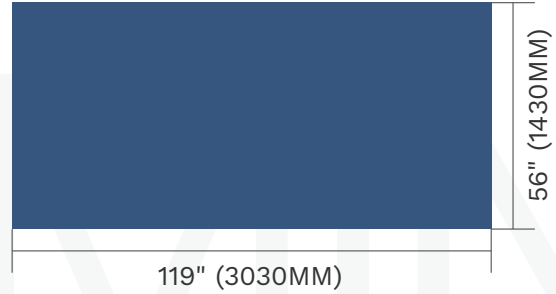
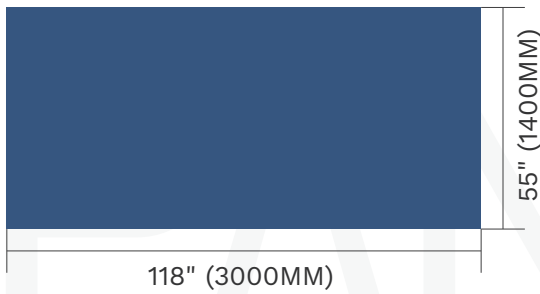

Quartz Thickness: 12 MM, 15 MM, 18 MM, 20 MM, 30 MM





NOTE: Not all colors are available in all sizes and thicknesses.

The slab dimensions are used for reference of storage and transportation purposes. Actual availability varies from slab to slab. It should be checked that the gray area around the perimeter for color, polish, transportation damage, or any other defect that may be visible for the maximum availability width and length of the slab. If the slab proves to be inappropriate, it should be replaced with another before cutting.

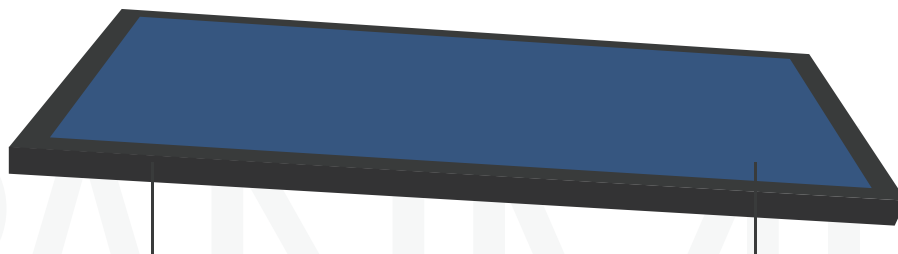

Be careful if using the gray-shaded area of the slab. It should be thoroughly inspected before fabrication. This area is going to be different from slab to slab and side to side.

The blue area represents the primary usable area of the slab.

Handling

The slabs are best loaded/unloaded from a container or truck with a forklift or lifting equipment able of handling at least 2,000 lbs. (900kg). Due to weight, appropriate safety shoes and gloves should be worn. 2cm material weighs 558 lbs. (253kg). 3cm weighs 836 lbs. (379kg).

Handle slabs either singularly or in multiples of two. Use clamps or sling straps and lift the slabs face-to-face. Take care to grab the slabs from the backside when face-to-face for better grip.

Vehicle Loads

It is the driver's responsibility to ensure the load is within the legal weight limit of the vehicle. We can't determine this at our premises. As a guideline, you must allow approximately 558 lbs. (253kg) per 2cm slab and 836 lbs. (379kg) per 3cm slab, plus the weight of any other items already loaded on the vehicle.

Securing the Load

It is the driver's responsibility to ensure that the goods are adequately supported and securely secured to the vehicle before leaving our premises.

Storage

Storing slabs in a manner that prevents warping. Use at least two support beams to hold the slabs in place. There should be no more than 15 slabs to each rack with the slabs face-to-face and back-to-back.

It is important to fasten slabs with straps in the early stages to keep them from warping as well as maintain a safe working environment. In addition, polished slabs should not expose to the sun as UV rays can damage the internal slabs structures.

It is necessary to keep the last slabs in each rack in a position in which the backside is facing out. Storage temperatures should not exceed 130°F.

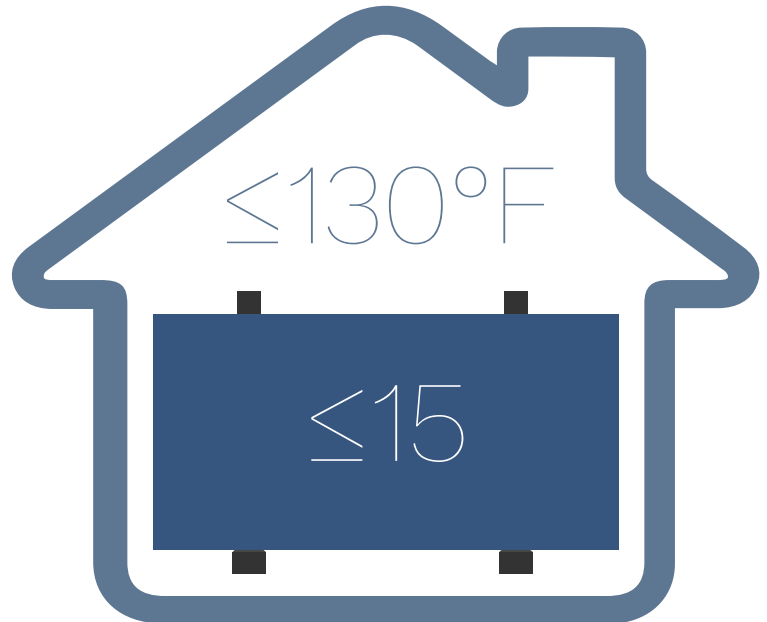

No more than 15 slabs to each rack with the slabs face-to-face and back-to-back. Storage temperatures should not exceed 130°F.

Visual Slab Inspection

When using PANMINQUARTZ, visual inspection for defects or color matching is necessary before cutting.

- Cracks**
- Color variation**
- Pits**
- Thickness tolerance**

- Flatness**
- Polishing Marks**
- Scratches**
- Residual Color**

- Gloss**
- Black Dots**
- Voids**
- Color Pigments**

We will not accept any of the above claims if the slab is modified in any way. The fabricator is responsible to determine whether the slabs are suitable for use. If not, it should be exchanged before cutting or modified.

Color Match & Pattern Irregularity

One of the basic elements of slab inspection is checking for a color match before cutting. Due to the innate and complex mixture of natural minerals, slabs for color variations may arise from different production cycles. Visual inspection is important to confirm color consistency.

PANMINQUARTZ shows random distribution throughout each slab. If any irregular grain distribution in the slab, the fabricator must determine if the slab is fit for purpose. If not, the slab should be replaced before cutting.

Product Technical Data

Specifications	Test Method	Results
Water Absorption	ASTM C97	≤0.05%
Density	ASTM C97	2200 - 2400 KG/M3
Flexural Strength	ASTM C880	Dry: 41.8-55.1 Mpa Wet: 47 - 62 Mpa
Compressive Strength	ASTM C170	Dry: 184 - 285Mpa Wet: 192 - 272Mpa
Modulus of Rupture	ASTM C99	Dry: 41.5 - 56.3Mpa Wet: 43.1 - 55.5Mpa
Bond Strength	ASTM C482	3.98 Mpa
Abrasion	ASTM C241	42 - 52
Freeze-Thaw Resistance	ASTM C1026	No obvious damage
Surface Burning	ASTM E84	Class A
Thermal Shock	ASTM C484	No visible defects
Thermal Conductivity	EN 12664:2001	0.469 - 0.504 W/(m/K)
Chemical Resistance	ASTM C650	Not affected

NOTE: The values quoted above are an average range of values of the different products tested and should be considered as an indication only.

Guideline for Respirable Crystalline Silica Health Hazards & Protection

Introduction to Guide

As a responsible quartz manufacturer, we at PANMIN consider providing a risk-free environment for all employees and in compliance with all local laws, as a foremost interest.

PANMINQUARTZ are manufactured without any type of when transported, shipped, or transported used by the end consumer. However, fabricating and processing the slabs generate respirable crystalline silica dust.

Therefore, this guideline aims to:

Provide information on the risks and hazards associated with working in an environment with respirable crystalline silica are created.

Provide certain information to assist in reducing workers' exposure to respirable crystalline silica dust, including guidance on the safe use and protective measures available for products containing crystalline silica in the workplace.

What is Crystalline Silica

Crystalline silica is a common mineral found in the earth's crust. Materials like sand, stone, concrete, and mortar contain crystalline silica. It is also used to make products such as glass, pottery, ceramics, bricks, and artificial stone.

Respirable crystalline silica – very small particles at least 100 times smaller than ordinary sand you might find on beaches and playgrounds – is created when cutting, sawing, grinding, drilling, and crushing stone, rock, concrete, brick, block, and mortar. Activities such as abrasive blasting with sand; sawing brick or concrete; sanding or drilling into concrete walls; grinding mortar; manufacturing brick, concrete blocks, stone countertops, or ceramic products; and cutting or crushing stone result in worker exposures to respirable crystalline silica dust. Industrial sand used in certain operations, such as foundry work and hydraulic fracturing (fracking), is also a source of respirable crystalline silica exposure. About 2.3 million people in the U.S. are exposed to silica at work.

Workers involved in manufacturing, finishing, and installing natural and manufactured stone countertops are at risk for significant crystalline silica exposure. Crystalline silica commonly occurs in nature as the mineral quartz and is found in granite, sandstone, quartzite, various other rocks, and sand. Workers who inhale very small crystalline silica particles are at risk for silicosis – an incurable, progressively disabling, and sometimes fatal lung disease.

Silicosis results in permanent lung damage. Silica dust particles become trapped in lung tissue, causing inflammation and scarring and reducing the lungs' ability to take in oxygen. Symptoms of silicosis can include shortness of breath, cough, and fatigue, and may or may not be obviously attributable to silica. Workers exposed to airborne crystalline silica also are at increased risk for lung cancer, chronic obstructive pulmonary disease (COPD), and kidney disease.

Work Operations Releasing Crystalline Silica Dust

Finished manufactured stone products, including finished countertops, do not present a health hazard themselves. However, cutting, grinding, chipping, sanding, drilling, and polishing natural and manufactured stone products can release hazardous levels of very small, crystalline silica dust particles into the air that workers breathe. Working with ground quartz in the countertop manufacturing industry can also expose workers to dangerous silica dust.

Workers operating powered hand tools, such as saws, grinders, and high-speed polishers, have some of the highest silica dust exposures in the countertop manufacturing, finishing, and installation industries. These exposures come from dry cutting, grinding, edging, and contouring stone, and may occur in shop environments as well as on job sites where finishing work is completed.

In the manufactured stone industry, workers may also be exposed to silica dust when opening bags of ground quartz, moving or mixing bulk raw materials, cleaning and scraping mixers, or cleaning dust collector baghouses.

Workers performing other tasks in areas close to where silica dust-generating operations occur may also be exposed. Without proper engineering controls, such as water sprays or local exhaust ventilation (LEV), and personal protective equipment (PPE), where appropriate, workers can inhale silica-containing dust from these operations.

What is OSHA

The Occupational Safety and Health Administration (OSHA) is a large regulatory agency of the United States Department of Labor that originally had federal visitorial powers to inspect and examine workplaces. OSHA's mission is to "assure safe and healthy working conditions for working men and women by setting and enforcing standards and by providing training, outreach, education, and assistance".

Prevention Measures

The Occupational Safety and Health Administration (OSHA) and the National Institute for Occupational Safety and Health (NIOSH) have identified exposure to silica as a health hazard to workers involved in

manufacturing, finishing, and installing natural and manufactured stone countertop products, both in fabrication shops and during in-home finishing/installation. This hazard can be mitigated with simple and effective dust controls in most countertop operations.

Engineering controls and work practices provide the best protection for workers and must be implemented first before respiratory protection is used. Working with industry partners, NIOSH and OSHA have identified the following control options for countertop manufacturing, finishing, and installation operations:

Engineering controls and equipment changes for manufacturing and finishing

1. Use water spraying systems and remote-controlled tools at the impact site where a saw or grinder generates dust.
2. Large bridge or gantry-like saws usually use water sprays and can be remote-controlled for dust control and cooling.
3. Hand-held angle grinders can be modified to deliver water to the point of contact with the stone.
4. Wet-edge milling machines or stone routers can replace dry grinders in shops. They provide a clean edge profile with a diamond wheel.
5. Use hand tools (e.g., drills, masonry saws, grinders) equipped with a shroud and a vacuum with a high-efficiency particulate air (HEPA)-filter when wet methods are not practicable.
6. Install LEV systems at fixed locations to capture dust at its point of origin.
7. Use a combination of both water and ventilation controls, if necessary.

Work practices

1. Use wet sweeping or HEPA-filtered vacuuming instead of dry sweeping or compressed air.
2. Replace water and air filters as needed to control dust.
3. Adjust water flow as necessary to control dust, following manufacturers' recommendations for water flow rates.
4. Pre-wash stone slabs prior to cutting.
5. Implement regular and thorough housekeeping procedures for water slurry and settled dust.
6. In high exposure areas, such as where cutting or polishing work generates silica dust, provide HEPA-filtered vacuums for cleaning worker clothes and water for hand, face, and hair cleaning.

Identify and isolate remaining dust-generating operations

1. Through air monitoring, identify high exposure activities associated with countertop finishing operations. These likely involve angle grinding, other types of grinding, and cutting with saws.
2. Isolate the silica dust-producing operation(s) using enclosures or walls. Enclosures are more effective when used with LEV.
3. Alternatively, enclose the person, if possible, by putting him or her in a control booth.
4. In some severe cases, it may be necessary to isolate some finishing tasks in separate areas. This may be needed more frequently for manufactured stone because of its high silica content.

For installation operations in commercial and residential spaces

1. Do as much work as possible under controlled shop conditions instead of on-site, or perform work outdoors or in well-ventilated areas to reduce respirable crystalline silica dust exposure.
2. Wet methods for dust control may not be practicable on or near finished cabinets, walls, and floors, so other suppression methods (e.g., LEV) should be used during these operations.
3. Use grinding and drilling tools equipped with dust shrouds coupled with LEV and a HEPA filter. Controls can be either tool mounted (drills) or attached to a vacuum system.
4. Use a HEPA-filtered vacuum to clean up dust as soon as practicable.

Provide respiratory protection when it is needed to protected workers

When engineering and work practice controls do not limit silica exposures to OSHA's PEL, employers must provide workers with respirators. Whenever respirators are required, the employer must have a respiratory protection program that meets the requirements of OSHA's Respiratory Protection standard (29 CFR 1910.134). This program must include proper respirator selection, fit testing, medical evaluations, and training.



The workers shown above are wearing a NIOSH-approved N95 filtering facepiece respirator (left), a full facepiece elastomeric respirator (center), and a loose-fitting powered air-purifying respirator (PAPR) (right).

If respirators are provided, use at least a NIOSH-approved N95 respirator. If the silica level is more than 10 times the PEL, a half-face respirator is not protective enough and a respirator that offers a greater level of protection, such as a full-facepiece respirator that will protect workers at silica levels up to 50 times the PEL, must be used. Powered air-purifying respirators (PAPR) also provide more protection than half-face air-purifying respirators. In general, workers find PAPRs to be more comfortable than pressure-demand respirators, including tight-fitting elastomeric varieties.

Provide training and information to workers about the hazards of silica and other chemicals

OSHA's Hazard Communication standard requires that employers provide their workers with training and information about hazardous chemicals used in the workplace. Employers must provide training and information to workers in a manner and language that the worker can understand. Employers must:

1. Prepare and implement a written hazard communication program.
2. Provide training and information on the hazards of silica and other chemicals used in the workplace.
3. Provide workers access to Safety Data Sheets (SDSs) on silica and other hazardous chemicals they are exposed to during countertop manufacturing, finishing, and installation.
4. Ensure that each container of hazardous chemicals is labeled appropriately.

Consider medical monitoring for workers who are exposed to silica

As part of its National Emphasis Program on Silica, OSHA recommends that employers provide medical exams to all workers who may be exposed to silica levels at or above one-half the PEL. Recommended medical tests include:

1. A medical exam that focuses on the respiratory system and includes work and medical history.
2. A chest X-ray, evaluated by a qualified professional.

Disclaimers

The information of Respirable Crystalline Silica Health Hazards & Protection mentioned above is an excerpt from OSHA. It is impossible to cover all the details regarding crystalline silica dust in the workplace. In addition, none of the content in this guide may be construed as a recommendation for using any product or tool in violation of any laws, safety practices, or other applicable terms. Laws and regulations of silica dust are different from country to country. We suggest you check and observe local legislation related to working in environments containing hazardous dust. Local regulations shall take precedence over these guidelines.

NOTE: This guideline is excerpted from OSHA (Occupational Safety and Health Administration) for reference. Fabricators can operate according to the actual situation of respective countries and regions.

PANMIN

Fabrication Instructions

Tools and Safety Equipment

It is important that all fabricators have essential tools and safety equipment to efficiently produce finished products. The following is a list of required or recommended tools:

Basic Tools

Bridge saw
 Electric/pneumatic polisher (variable speed preferred)
 Diamond grinding wheel
 Diamond polishing pad
 Grinding stone
 Core bits
 Diamond contour blade
 Wet profiling machine (edge router)
 Stone carts/dollies
 A-Frame/storage racks
 Fabrication stands
 Air compressor
 Seaming clamps
 Water source

Advanced Tools

Water jet
 CNC
 Automated profiler
 Diamond jigsaw

Basic Safety Equipment

First-Aid kit
 Safety glasses
 Dust masks
 Safety gloves
 Steel-capped safety shoes
 Aprons
 Earplugs

Basic Fabrication Guidelines

In order to ensure high-quality products, the following guidelines should be followed:

1. To avoid overheating the slab, only water-cooled tools should be used for cutting, drilling, and polishing PANMINQUARTZ.
2. Do not alter the original surface finish of the slabs by re-polishing, honing, sealing, or otherwise altering the factory finish.
3. When cutting inside corners, be sure to use a core bit to avoid damaging the corner area with the cutting disc. Damage to the radius area will produce a stress point.
4. Do not cut square corners (cross-cut) as this will create stress points in the slab and may result in cracking.
5. Any internal angled corner must be radiused. Cut with the saw up to the joint of the drilled hole, leaving the drilled hole intact. Avoid dry grinding/polishing of the corner since overheating the area may result in a crack.

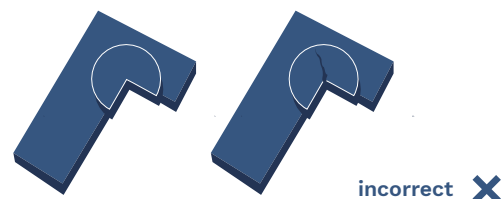
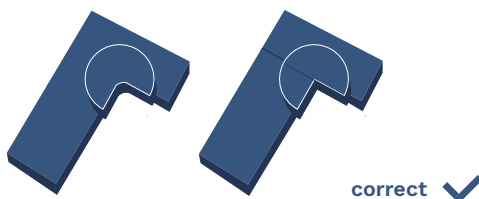

Insider Corners

Regarding an angular-shaped kitchen ((L- or U-shaped), the surfaces of the countertop should be fabricated from a single slab. The interior corners must have a minimum $\frac{3}{8}$ " radius.

Cutouts

1. If the distance between the cutout and a joint is less than 6", the area needs to be supported. This can be achieved by ensuring that all joints are placed at the joint of the base cabinet or by installing a solid slat under the joint.
2. Damage to the drilling area may result in subtle cracks at stress points. All cuts should be made using wet diamond cutting tools to avoid generating excessive heat, which could also cause hairline cracks.
3. Always allow an extra $\frac{1}{8}$ " between the device and the edge of the cutout for expansion.
4. Cross-cutting should be avoided. Always using a core bit when preparing a cutout.

NOTE: Chiseled or hammered edges are not approved edge details.

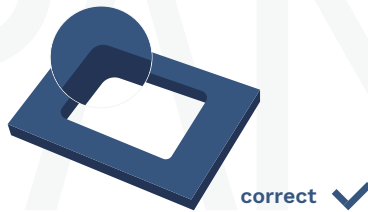

Seams

1. All seams are levered by adjusting the material before adhesive sets.
2. Do not surface polish seams to make them even/level.
3. If a straight seam is not used, any internal angled corner in the seam must have a $\frac{3}{8}$ " radius.
4. Use a state-of-the-art seam setting tool to keep the seams as narrow and unobtrusive as possible. The seams width shall not exceed $\frac{1}{16}$ ".

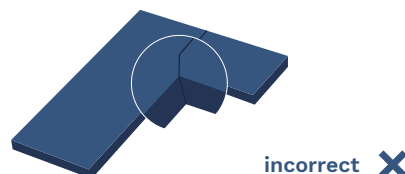
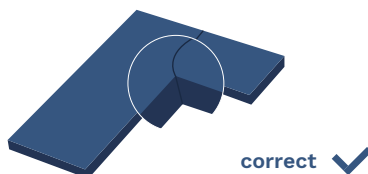

Edge Detail

1. All exposed edges must be made to the same finish as the surface and all edges must have a minimum edge profile of 3-4 mm (1/8”).
2. The top and bottom of edges must be rounded or beveled and our preferred edge detail is a Pencil Round edge.
3. The larger the surface area of the edge, the more resistant it is to chipping.
4. For areas with high traffic/abuse, PANMIN suggests that the edge details have a minimum of 5 mm (3/16”) radius on both top and bottom, and a minimum of 6 mm (1/4”) on outside corners.

Polishing Edge Profiles

The edge profile of any PANMINQUARTZ should be polished in a gradual manner, only granite or marble diamond polishing pads. PANMIN recommends a superior pad and the use of sufficient water for best polishing results. PANMINQUARTZ should be polished from smooth, clean as well as free from any residual adhesive. Care must be taken not to over-polish edges beyond the factory surface polish.

Recommended PANMINQUARTZ polishing process:

1. Honed finish 100, 200, 400-grit diamond pad
2. Polished finish 100, 200, 400, 500–800, 1500–2000, 2000–3000-grit diamond pad

These recommendations are a guideline for achieving a polish equal to the factory surface polish. The type of tools, manufacturing techniques, and diamond pads will affect the actual polishing results. When polishing the edge profile, use water-cooled tools as the dry-polishing profile may cause overheating, making the edge prone to chipping. Overheat undermines the slab’s physical structure, although invisible to the naked eye, micro-fissures are formed, resulting in chipping upon impact, discoloration, and an uneven polish. Here are some suggestions for reference.

3. Do not use stone “buff” pads on PANMINQUARTZ.
4. Do not over-polish edge details beyond factory surface polish.
5. Use lower RPM to be used on polishers when using 1000-grit or higher diamond polishing pads.

Mitered Edges

1. Mitered edges should be made at a 45° angle to ensure maximum strength. The joint should be clean, flush, and parallel.
2. Chipping is most prevalent where the application of the adhesive is not evenly distributed throughout the joint.
3. Mitered edges have the largest area of weakness and are most prone to chipping. (Our recommended minimum edge profile is a 1/8” bevel. Our preferred minimum edge profile is a 1/8” (3–4mm) Pencil Round edge.)

4. Incorrect angles limit the type of edge that can be generated as the larger the edge profile, the larger the visible joints.
5. Do not cut edges at less than 45° as this will make the edge vulnerable to physical damage such as chipping.
6. Make sure the adhesive is thoroughly distributed throughout the joint for maximum strength.

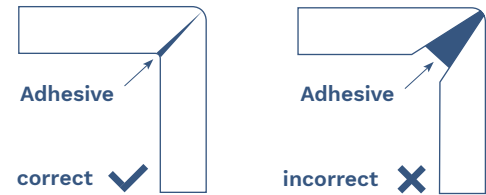

The Practice of Polishing Finish Edges

To achieve best-textured appearance, here are some procedures:

1. Before polishing, cut the surface into the required pieces/segments.
 2. Using clamps and attach all pieces required for the final design to a suitable working surface.
 3. Glue before polishing if needed to glue the edges.
 4. Cut or shape the required edge profile.
 5. Smooth and polish the edge shape, following standard polishing procedures and according to regular levels – up to a maximum of 100–120 grain.
 6. Using a great amount of water to achieve polishing of texture finish surfaces.
- Polishing a texture finish edge will require approximately the same amount of time as polishing a regular edge.
7. Using a suitable manual, electric, or pneumatic angle grinder with a low RPM of 600–1200. Connect it to the water source with a 60-grain special texture brush.
 8. Using movements similar to those used when polishing a regular edge when polishing the textured finish.
 9. Change the brush to a 120 grain and polish until there are no visible marks remaining of the 60-grain brush.
 10. Repeat with 400, 800, and 1600 grain brushes above until the edges match the surface texture.

Adhesives

Using flexible adhesives is essential, such as 100% clear silicone adhesive be used to secure the countertops to the cabinets, substrate, or to secure PANMINQUARTZ backsplashes to the wall. This will allow for limited thermal expansion. Epoxies, liquid nails, or construction adhesive, and other non-flexible adhesives do not compensate for thermal expansion. PANMINQUARTZ will not warrant any claims for cracks that are the result of tops being bonded to the base cabinets with non-flexible adhesives. Therefore, follow the stone adhesive manufacturer's instructions. Follow good stone working and safety practices at all times.

Seaming & Laminations

PANMIN requires that all fabricators follow the individual manufacturer’s instructions for the use of their seaming adhesives, including but not limited to the minimum working temperatures for their product. Failure to follow the prescribed instructions will void the PANMINQUARTZ warranty. PANMIN recommends the use of a polyester resin knife-grade adhesive as well as the Integra Estone 101 & Tri-Bond 30 cartridge system for all seaming and laminations.

Joint Adhesives

The adhesive used must be pigmented to a color similar to that of the material being installed which can be achieved by using color paste pigments mixed with the adhesive.

Laminations/Double Edges

It is important to make sure that the lamination piece is the full length of the top piece and cut at 45° on the corners when laminating. If it is impossible and a joining of the lamination pieces is unavoidable, the joint must be cut at 45°. Mitered end cut can be used for reducing stress on the material that may cause stress fractures. The laminating strips should be cut from the same slab as the countertop surface material to ensure consistent color. When cutting the piece to be laminated, it is recommended to add the lamination piece size to your cutting measurements to make sure you will have the same color piece and same length for your lamination.

1. Use full-length lamination pieces.
2. A 45 ° corner joint is recommended to minimize the stress on corners.
3. For very long countertops where a joint is required, ensure that the joint in the lamination piece is at 45 ° to reduce any stress points.

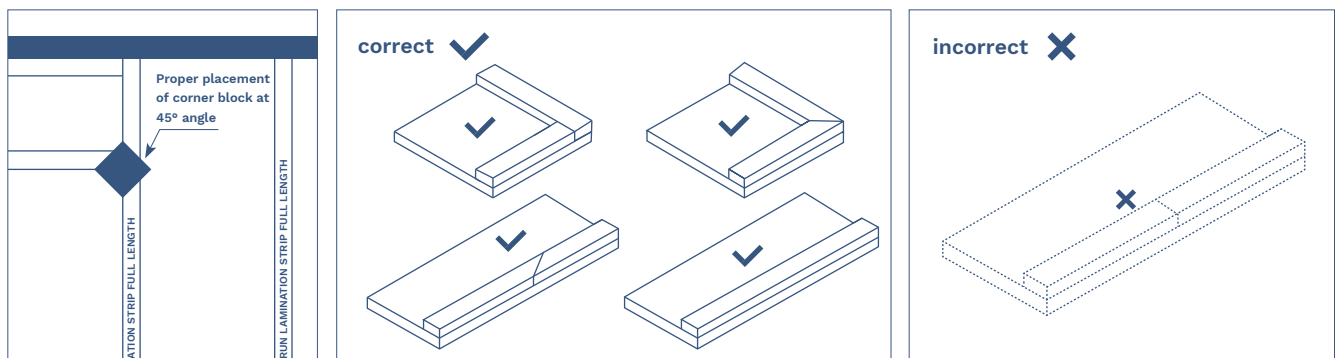

Seaming

1. All seam surfaces should be smooth and free of debris.
2. Use the advanced seam setter tool to minimize seams. Seams should not more than 1/16” wide.
3. PANMINQUARTZ requires the use of colored glue for all seams which can be done by using one of the premixed Integra colors available or by manually tinting the glue of your choice.
4. Never install mechanical fasteners (screws, nails, etc.) into PANMINQUARTZ.
5. PANMINQUARTZ should not be allowed the surface polishing of seams.
6. Grooves should be created on the surfaces to be attached to make room for glue. Additional glue should be placed at all corners and around joints. Please refer to picture A and B for details.

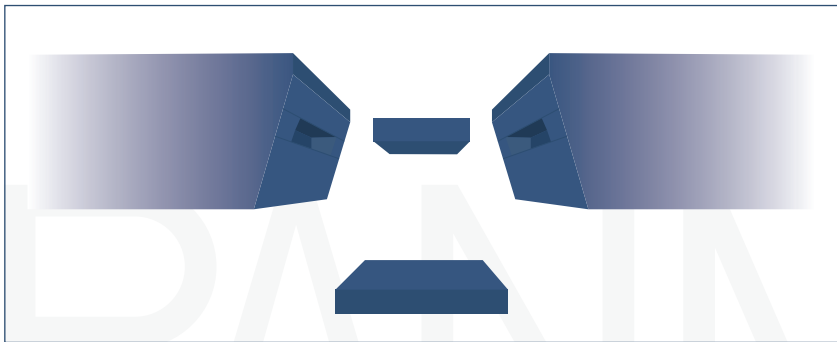

Picture A

The illustration shows the use of a beveled edge and biscuit joint to strengthen the seam. If using this technique, be sure to bevel only the seaming edge up to 1” behind the exposed surfaces.



Picture B

Joint Positions Seam over dishwasher (not recommended)

1. If the seams must be located above the dishwasher, use full deck-isolated support is needed. This will allow appropriate support and allowances for thermal movement.
2. When installing 3/4” (2cm) material the plywood sub-top over the dishwasher must be isolated from the rest of the sub-top. This should be done by allowing 1/8” clearance on either side of the full deck support.
3. It is necessary to grind notches or grooves on the surfaces to be bonded together on seams, miters, and lamination areas. PANMINQUARTZ is nonporous and will not absorb the adhesive – these notches provide a space for the adhesive within the joint.

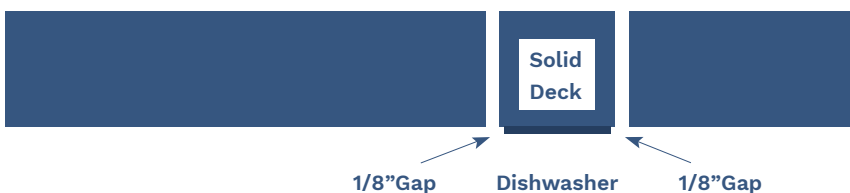

Transportation

Since the stone itself is very heavy and fragile, portability must be taken into account when packaging and transportation. Here are three tips to refer to:

1. Brace all cutouts to avoid flexing of the seams and corners.
2. Make sure the surface of the slabs is always protected and not touching metal, the back of other slabs.
3. Transport PANMINQUARTZ with sections touching face-to-face or back-to-back.
4. A removable “A” frame can be used for stone slab transportation as it can hoist off the delivery vehicle.
5. The slabs should be securely fastened to the rack by straps.
6. There should be a protective layer between the rack and PANMINQUARTZ as it can prevent damage during storage and transportation.
7. At least two people are needed to transport the product to the site by the delivery vehicle.

PANMIN

Installation Instructions

Preparing Base Units/Cabinets

Check the installation of the cabinets to the cabinet is fully installed and level. The tops of the cabinets must be flat and no more than 1/16" (1.5mm) over 18" (457mm). The cabinets should be attached and then fixed to the back wall. In the case of a dishwasher, make sure that the surrounds of the opening of the counter will have sufficient support. The front edge of any countertop over a dishwasher should always be supported with material matching the installed cabinets to better match the kitchen.

NOTE: If the cabinets do not meet the minimum standards, the homeowner or project manager should be notified to present at the job site by the installer before installing tops.

Support

Here are some guidelines for installation, material, and type of supports:

1. PANMINQUARTZ must be supported on a strong perimeter frame.
2. Front-to-back support within the cabinet should be provided every 24".
3. Plan for front-to-back support strips 2.5"-wide (40mm-100mm) to coincide with cutouts and periodic support.
4. Support is needed across the top of a dishwasher space and over an under-counter oven.
5. Support must be provided under all countertop joints.

Overhangs

The overhangs of PANMINQUARTZ require support. The following guidelines are for standard cabinets 24" in-depth:

2CM (3/4")	2CM (3/4") with 5/8" sup top	3 CM (11/4")	MATERIAL SUPPORT REQUIRED
Less than 8" (200mm)	Less than 12" (300mm)	Less than 16" (400mm)	No additional support required.
8-16" (200-400mm)	12-20" (300-500mm)	16-24" (400-600mm)	Brackets required at 24" (600mm) intervals.
Over 16" (400mm)	Over 24" (500mm)	Over 24" (600mm)	Legs, Columns or Panels required at 24" (600mm) intervals.

Fitting

1. PANMINQUARTZ needs room to expand so there should always be space. Each countertop requires at least 1/8 "expansion and contraction in each wall.
2. Mechanical fasteners (screws, nails, etc.) should never be fixed directly to PANMINQUARTZ. Bolted connection is allowed.
3. When affixing the PANMINQUARTZ surface to the supports, use only dabs of flexible silicone 8–12" apart. The extra adhesive must be placed along all joints and cutouts.

Countertop Adhesive

We only recommend using 100% silicone adhesive for affixing the PANMINQUARTZ surface onto the cabinets and for all supports.

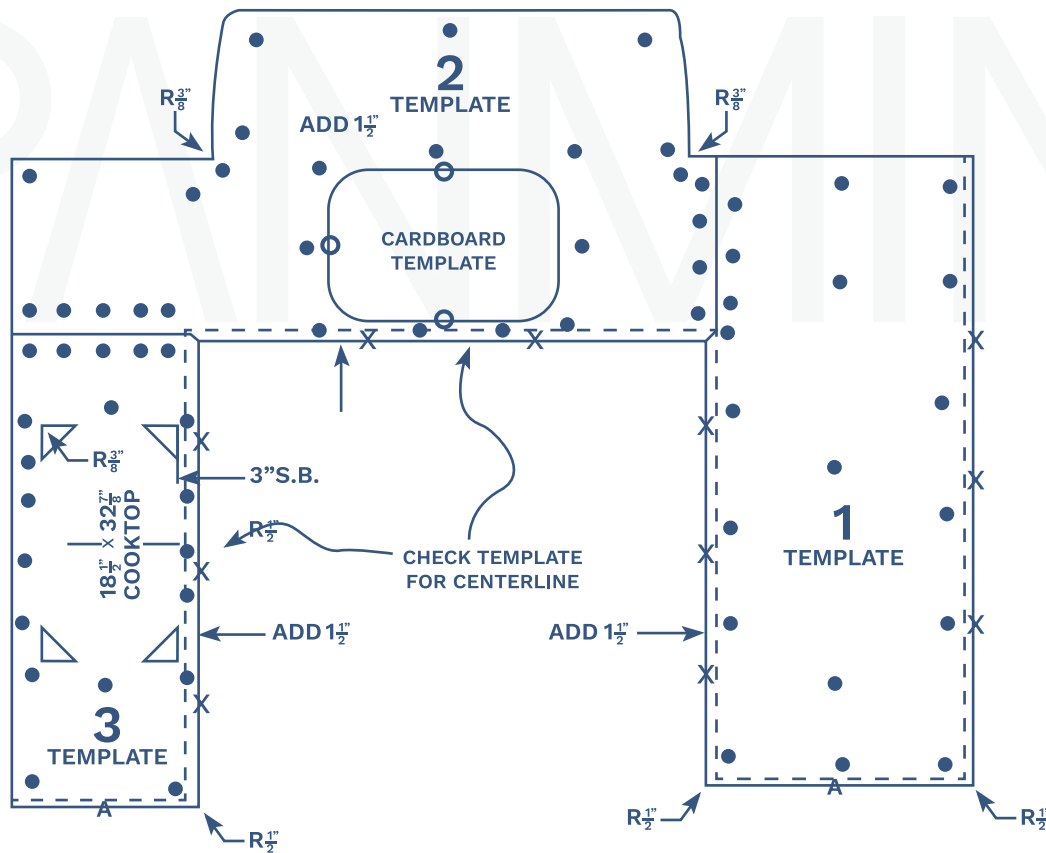

Securing of Countertops

1. Fix top using dabs of silicone 8–12” apart.
2. Support is required on overhangs over 8” (200mm) for ¾” (2cm) thick slabs and 16” (400mm) on 1¼” (3cm) slabs.
3. Use extra silicone on all corners, joints, and around all cutouts.
4. Join the seams together with a color-matching adhesive.
5. Radius all inside corners on all cutouts.
6. Allow for extended space between the tops and walls.
7. Do not undercut corners.
8. Before installing the tops, all cabinets must be leveled and supported.
9. If the cabinets are on adjustable legs, make sure that all legs are evenly tensioned to prevent any movement.

Sinks and Basins

We recommend you follow the sink manufacturers’ recommendations for all sink or basin installations, no matter top-mount or under-mount.

1. For under-mount installations, follow the minimum edge profile recommendations around the cutout to reduce the risk of chipping. Our recommended minimum edge profile is a 1/8” bevel. Our preferred minimum edge profile is a 1/8” (3–4mm) Pencil Round edge.
2. Twin basin installations (Top- or Under-mount), where the tap hole is in the countertop, require extra care to ensure that there is sufficient material left for strength.
3. In order to prevent stress points in the top, all sink cutouts must be made using drilled radius corners (minimum 3/8”).
4. We recommend that all sink installations be fully supported independently of the PANMINQUARTZ top. Be sure to use a professional sink-setter or support rail system. Plan for front-to-back support strips 2.5”-wide (40mm–100mm) to coincide with cutouts and periodic support. All countertop joints must be supported.
5. Never install mechanical fasteners (screws, nails, etc.) into PANMINQUARTZ.

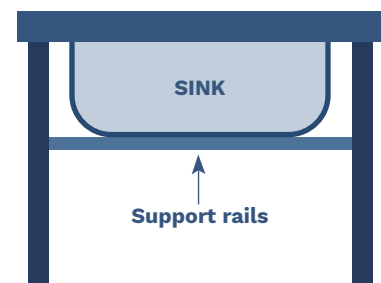
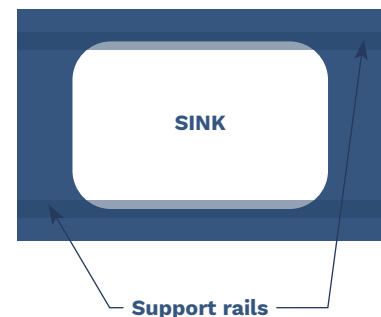
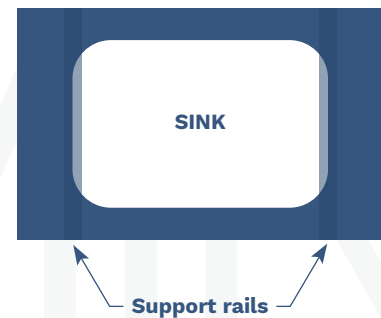

Under-mount sink installations

1. All under-mount sinks should be sealed with 100% silicone on the countertop.
2. All under-mount sink cutouts must have the inside edges polished to match the surface.

Table Tops

If you are using PANMINQUARTZ as a freestanding tabletop, pay attention to the method by which the top is secured to the base. This is the most important when the table has only one central leg to support it. A silicone adhesive may be too flexible to adequately secure the PANMINQUARTZ top to the base. PANMIN would recommend using a stronger, harder adhesive such as building adhesive like polyurethane [Sika-Flex] that is strong yet still flexible to ensure that the top is properly fixed to the base.

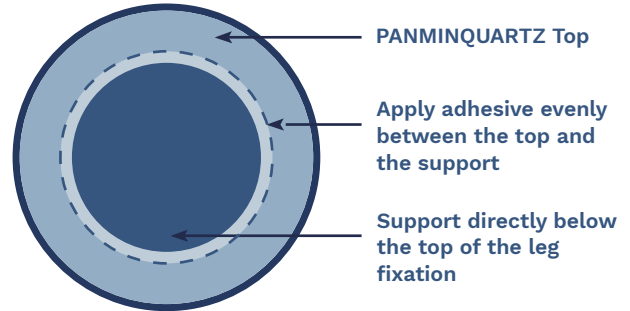

Wall Applications

The structural requirements of PANMINQUARTZ require that the walls covered be strong, safe, and hard and comply with all applicable laws and engineering practices. PANMIN recommends only the use of latex thin-set mortar adhesive or epoxy adhesive and grout for all wall applications. All bedding and grouting mortar shall be weather-resistant, frost-resistant, shockproof, and chemical corrosion-resistant, and shall meet the following physical requirements:

Compressive Strength:	Thick-bed mortar	3000 PSI Minimum
Compressive Strength:	Thin-bed, bonding, grouting mortars	500 PSI Minimum
Tensile Strength:	Thin-bed, bonding, grouting mortars	500 PSI Minimum
Water Absorption		4%
Ozone Resistance:	200 hrs @ 200ppm	No loss of strength
Smoke Contribution Factor		0
Flame Contribution Factor		0

1. Observe good stone working and safety practices at all times and comply with applicable building codes and regulations.
2. PANMINQUARTZ is suitable for concrete, block, and masonry-type surfaces, gypsum wallboard, plasters, cement backer board, plywood, asphalt, and steel, properly prepared and with the appropriate adhesives and grout.
3. The finished mortar and grout should be resistant to urine, diluted acid, dilute alkali, sugar, brine, and food waste products.
4. PANMINQUARTZ and its setting and grouting mortar do not constitute a waterproofing barrier and should not be considered as an alternative waterproofing membrane. For information on thin, load-bearing waterproof membranes, please consult your preferred supplier.
5. PANMINQUARTZ surfaces to be bonded must be free from dust, oil, grease, paint, tar, wax, curing agents, primers, sealers, form release agents, or any other harmful substances that can act as bonding barriers.
6. It is the installer's responsibility to ensure that any such contaminants are removed before the PANMINQUARTZ installation.
7. All mortar additives, epoxy adhesives, and grouts should be from one manufacturer to ensure compatibility.
8. All PANMINQUARTZ should be treated without fragmentation, breakage, or intrusion of foreign matter.
9. Handle, store, mix and apply all set and grouting materials in strict accordance with the manufacturer's instructions.

Finishing Touches

It is important to let your customers know that any successive trades must not use the new countertop as a workbench, a stepping, or a standing platform and that any trades using solvents or adhesives should take due care to avoid and/or remove any spills created by their solvents or adhesives. In addition, if further construction work is to be carried out at the work site after the surface installation is complete, ensure that the entire top of the PANMINQUARTZ is covered with corrugated cardboard or other protective material to properly protect the PANMINQUARTZ. PANMIN recommends at the period of finishing touches, your customer should confirm in writing, their satisfaction with the material and workmanship to cover you against damages caused by others.

Returning Slabs

Any slab that does not fit should be returned for credit or exchange before altered in any way. No restocking fee is applied if returned within seven days. After seven days a restocking fee may apply.

OSHA Policy

The Distributor has an OSHA Policy in place to ensure the safety of all persons on our premises. All visitors must follow the instructions of our staff and obey any warning signs posted in the warehouse.

Requirements for Drivers

1. Drivers should make sure the slabs are properly loaded.
2. Contract drivers should be made aware of which orders are to be collected. This is especially important when several orders are waiting for pickup or delivery. The distributor will not be responsible for additional costs for missed goods on the first delivery.
3. Drivers are not allowed to roam around the warehouse unless accompanied by an authorized person.

PANMIN

Care and Maintenance

PANMINQUARTZ is a premium quality solid non-porous product that is highly resistant to stains caused by fruit/vegetable juices, liquid food coloring, coffee, tea, wine, soft drinks, olive oil. Normal cleaning with a damp cloth or paper towel, and if possible, a small amount of mild detergent is all you need to keep your PANMINQUARTZ looking great. Once clean, rinse and dry the surface thoroughly. To avoid a dull surface, be sure to use a non-abrasive cleaner and rinse thoroughly after use. PANMINQUARTZ requires minimum maintenance and following the care and maintenance guidelines will help to keep the surface in good condition for years.

REGULAR CLEANING

1. Cleaning Stubborn Stains or Dried Spills

If needed, apply common, non-abrasive, household cleaners directly to the affected area for a few minutes. Soak the affected area with pads of paper towels for 5 to 10 minutes. Scrub the area gently with a non-scratch pad in a circular movement. Rinse off any cleaner with clean water thoroughly. Then dry with a soft cloth or paper towel thoroughly. If necessary, apply Windex streak-free as the final step to clean any gel residue.

2. Removing Adhered Materials

Adhered materials refer to materials like gum, nail polish, paint, or any other foreign matter. First, carefully scrape away the excess material with a plastic putty knife or a razor. And then clean the surface with a damp cloth to remove any marks left behind and any residual dirt. Also do not use abrasive pads to clean tougher dirt as abrasives can damage the finish/sheen of your countertops. Any gray marks left by the blade can be removed with household cleaners and ordinary scouring pads. If necessary, use Windex streak-free to rinse and clean any gel residue.

3. Textured Finishes Cleaning and Maintenance

Texture Finishes refer to finishes other than polishing finishes, such as honed finishes, leathered finishes. These finishes require more cleaning than our polished finish. Fingerprints, grease, wet spots, metalmarks, and other signs of daily living show more on these types of surfaces. Most of these marks can be easily removed with little effort and non-abrasive cleaning products such as Soft Scrub Liquid Gel. These types of finishes are not recommended for high-traffic areas.

CAUTION

1. Avoid Chemicals & Solvents (Cleaners)

Quartz can be permanently damaged by prolonged exposure to strong chemicals and solvents. It is advisable to avoid exposing PANMINQUARTZ to chemicals with PH levels outside of the range 5-8,

such as grill cleaners, floor strippers, paint removers/furniture strippers, toilet bowl cleaners, the product with pumice, oil soaps, tarnish, or silver removers, furniture cleaners, drain products, battery acid, dishwasher detergent, etc. If the surface of your PANMINQUARTZ is accidentally exposed to any potentially damaging products, rinse immediately with water to neutralize the effect.

Do not use abrasive or strong alkaline/acid or free radicals or oxidizers or the like (whether high, neutral, or low PH) cleaners. Various chemicals are corrosive and/or erosive in their ability to attack any structure including PANMINQUARTZ. Be very aware of these potential damages to your product.

2. Avoid Scratch & Hitting

PANMINQUARTZ is durable and more resistant to surface damage than other stones. However, all stones can be damaged by force and no stone is chip-proof. Objects hitting edges particularly at sinks or dishwashers may cause chips. Though a minor knife slip will dull the knife and not harm PANMINQUARTZ, no stone surface is scratch-proof. Surface markings are more visible on mono stone designs than multi-colored surfaces. The use of a cutting board is always recommended when using sharp knives. Care should be exercised when moving heavy objects, and avoid dropping heavy kitchen tools, particularly on the edges of sinks or dishwashers.

3. Heat Caution

PANMINQUARTZ is designed and manufactured to withstand moderate heat but the products are not heatproof. Like any other composite material, PANMINQUARTZ may be damaged by sudden or lasting exposure to high temperature resulting in cracks, especially at the edges and cutouts of the product. To prevent thermal shock, discoloration, or other damages, it is necessary to use insulating pads when putting hot objects on the surface. Keep PANMINQUARTZ away from open flames and avoid prolonged contact with very hot pots. We always recommend using a hot pad or trivet, especially when using cooking units such as electric frying pans, griddles, crock pots, or toaster ovens. Do not put hot cookware directly on the surface of PANMINQUARTZ.

4. Avoid Sun Exposure

Minimize direct sun exposure to PANMINQUARTZ. Long-term exposure to direct sunlight may discolor the surface finish. PANMINQUARTZ is only for interior applications.

ATTENTION

1. Color Consistency & Uniformity

PANMINQUARTZ is pure natural quartz. Variation in the natural stone (quartz) color, pattern, size, shape, and shade are inherent and unique characteristics to be expected with this product. This does not affect the product's performance in any manner.

Color blotches are intended and designed into many products to enhance natural beauty. Samples are small select cuts from a slab; they do not exhibit all the characteristics of a design and therefore are not fully representative of what will be installed. The product will not be replaced due to these variations.

2. Support

PANMINQUARTZ is not a structural support product. The PANMINQUARTZ of 2 or 3cm thickness is for countertop only and must be supported. The PANMINQUARTZ of less than 2cm thickness is for surface finishes such as walls, tub and shower surround, and fireplaces. Horizontal applications such as a tub deck must be completely supported.

3. Installation

PANMINQUARTZ installation is optimized when walls and cabinets are properly prepared for installation. This includes but is not limited to structurally sound, straight, level, and square walls and cabinets, lack of which may cause poor installation and poor seam fit, or inconsistent countertop overhang and placement.

PANMINQUARTZ installation does not include qualification of any sink or stove cutouts (any cutouts), faucet hole locations, or cabinet sizes. PANMIN is not responsible for verifying whether sinks, stoves, or other cutout appliances, cabinets, and faucet hole locations fit together well, or at all. This is the responsibility of the owner, general contractor, or the like. PANMIN will fabricate cutouts as per supplied model/template information. PANMIN is not responsible for the accuracy of the information provided.

Proper care and maintenance of goods are the responsibility of the owner and/or other users. The Care and Maintenance Guidelines published at www.panmin.com are for reference.

PANMIN might update the guidelines at its sole discretion at any time. Following the up-to-date guidelines is highly recommended, which is helpful to keep your PANMINQUARTZ in good condition for years.

NOTE: PANMINQUARTZ ® IS THE REGISTERED TRADEMARK OF XIAMEN DEYUAN PANMIN TRADING CO., LTD.

Special Care Considerations Form

PANMINQUARTZ

Special Care Considerations for Textured Finishes

PANMIN provide various colors with different quartz textured finishes. Texture Finishes refer to finishes other than polishing finishes, such as honed finishes, leathered finishes. Please note that these finishes require more cleaning than our polished finish. Finger prints, grease, wet spots, metal marks and other signs of daily living show more on these types of surfaces. Most of these marks can be easily removed with little effort and non-abrasive cleaning products such as Soft Scrub Liquid Gel. These types of finishes are not recommended for high traffic areas.

By signing this document, you agree that characteristics of these unique finishes have been fully explained to you. You also understand that while PANMINQUARTZ has Residential 15 years Warranty, this warranty covers failures caused by product defects when the material is installed by PANMINQUARTZ Certified Fabricator. Temporary marks that are common on these finishes are not covered by our PANMINQUARTZ warranty.

For additional warranty information, please refer to Residential 15 years Warranty and Care and Maintenance part of PANMINQUARTZ website at www.panmin.com.

NAME OF PURCHASER		NAME OF DEALER/FABRICATOR	
SIGNATURE OF PURCHASER		SIGNATURE OF PURCHASER	
DATE		DATE	

Note: Copies of our Residential 15 years Warranty are available at the authorized fabricator. Residential 15 years Warranty has some restrictions apply. Visit www.panmin.com for more information.

Residential Lifetime Warranty & Commercial Limited Warranty

Residential 15 Years Warranty

PANMIN warrants to repair or replace its material that fails due to any manufacturing defect when fabricated and installed by a Certified Fabricator from the original date of installation. This warranty applies exclusively to the repair or replacement of failed material that has been permanently installed in your residence. The option to repair or replace the material is at the sole discretion of PANMIN. The cost of installation and/or fabrication is NOT covered under this warranty.

This Residential 15-Year Warranty is available only to the ORIGINAL OWNER of a single-family residence in which PANMINQUARTZ has been originally installed. In the case of a newly constructed single-family residence, this warranty is available to the “first” owner purchasing the residence with PANMINQUARTZ permanently installed.

This warranty is published officially at www.panmin.com. PANMIN might update the warranty clause at its sole discretion any time. But the specific version of warranty published on the original date of installation is binding upon you and PANMIN.

Terms and Conditions

1. This warranty applies only to PANMINQUARTZ and does not apply to any other products, including other quartz surfacing products manufactured or supplied by any other party.
2. This warranty applies only to PANMINQUARTZ that have been permanently installed in the interior of single-family residences and have not been moved or altered from their original installation. If after or during installation you decide that you do not like the color or finish you selected, that subjective decision is not covered under this warranty.
3. This warranty does not cover materials and/or services that have not been paid in full.
4. This warranty applies only to materials that have been maintained according to the PANMINQUARTZ Care & Maintenance guidelines. The Care & Maintenance guidelines are available at www.panmin.com.
5. To request service under this warranty, you must contact the company who sold you PANMINQUARTZ or contact PANMIN directly within thirty (30) days once the failure of PANMINQUARTZ occurs.

6. Following installation, you must register your product within thirty (30) days to activate your warranty at www.panmin.com. If no record of your warranty is on file, you must provide proof of purchase in the form of a copy of your original receipt or invoice showing the name of the owner, authorized dealer, and PANMIN certified fabricator. Upon receipt of your original receipt or invoice above, PANMIN will fully honor this warranty even though no register is on file. You must agree to cooperate with PANMIN or its authorized agents in the inspection of the product and assist us in efforts to perform our obligations under this warranty.

7. If PANMINQUARTZ fail due to a manufacturing defect, PANMIN will, at its sole discretion, repair or replace such materials. PANMIN will seek to obtain the best possible result, whether we decide to repair or replace your product. However, an exact color match is never guaranteed.

8. All decisions regarding this warranty are at the sole discretion of PANMIN and shall be final and binding on all parties. No representative, dealer, salesperson, distributor, fabricator, or any other person is authorized to make any warranty or promises on behalf of PANMIN.

9. This warranty expires upon transferring the ownership of the property to subsequent parties. This warranty is not transferable and does not cover claims made by subsequent owners of your home.

Exclusions

1. This warranty does not cover use for any commercial purposes. Commercial use includes but is not limited to, use in a store, rental properties, office, or any other place of business.

2. This warranty does not cover products installed in any outdoor places.

3. This warranty does not cover products used as flooring material.

4. This warranty does not cover improper use or abuse. Improper use or abuse includes, but is not limited to, damage from mishandling of the product, damage from excessive heat or uneven exposure to weather conditions, physical or chemical abuse, and damage from improper care and maintenance. Do not use cleanings products including oven cleaner, paint remover, or any other similar products, as they may undermine the surface.

5. This warranty does not cover chips or other excessive impact damage to the product.

6. This warranty does not cover scratches. PANMINQUARTZ is a very hard material and highly scratch

resistance but not scratch-proof. Proper care must be exercised including the use of a cutting board as part of your care and maintenance.

7. This warranty does not cover routine maintenance. Routine maintenance includes but is not limited to, minor conditions such as removing stains and water spots by following the techniques specified in the PANMINQUARTZ Online Care & Maintenance Guidelines at www.panmin.com.

8. This warranty does not cover failures due to fabricators/installers not following the prescribed fabrication and installation procedures as outlined by PANMIN. Improper fabrication and/or installation is the sole responsibility of the fabricator and/or installer.

9. This warranty does not cover any defects that were visible at the time of fabrication and were not avoided during fabrication. Fabricators are required to perform a visual inspection of all materials before fabrication and again before installation.

10. This warranty does not cover seam appearance or seam performance, adhesives, caulk, or other accessory items. Once the product is installed, the main reasons for seam separation or cracking are the shifting or movement of the substrate, cabinets or foundation, and thermal shock. Thermal shock can occur when a hot pan, dish, or other receptacle or object is left on the countertop for even a brief period. Trivets or hot pads should always be used. These issues are not considered material defects and are subject to proper care and maintenance by the owner.

11. This warranty does not cover any chemical damage.

12. This warranty does not cover any abnormal use of the material including bending or curving.

13. This warranty does not cover material that has been milled or reduced in thickness.

14. This warranty does not cover the installation of sinks, other plumbing fixtures, or appliances.

15. This warranty does not cover securing mechanical fasteners directly into the material.

16. This warranty does not cover any failures due to inadequate support for the installation. This includes overhangs over recommended support guidelines provided by PANMIN or an unsupported base.

17. This warranty does not cover any chips or cracks that are a result of “dry” cutting or polishing and/or not following the minimum requirements for edge details.
18. This warranty does not cover mitered edges where the joint is not cut correctly.
19. This warranty does not cover the alteration of any PANMIN factory-applied finish. Only colors listed as available in our brochure, sample book, or on our website as “honed” are eligible under this warranty. Any issues arising from the practice of “in-shop” honing are the sole responsibility of the fabricator.
20. This warranty does not cover temporary marks that are common to honed finishes such as metal marks, fingerprints, or other signs of daily living. A signed “Special Care Considerations for PANMINQUARTZ Textured Finishes” form is required to be submitted to PANMIN or its authorized representatives to receive coverage under this warranty. This form must be signed by the end-user /owner of the finished installation.
21. This warranty does not cover additional modifications or supplemental repairs such as structural changes, plumbing, electrical installation, tile, cabinets, flooring, etc. that may be necessary to repair or replace the PANMINQUARTZ covered under this warranty. The supply of these material and labor costs shall be the responsibility of the customer.
22. This warranty does not cover natural variations in the color, size, shape, and distribution of the pattern of the natural quartz or the natural variations in background tone. These characteristics are inherent and unique characteristics of the product. Color samples provided to consumers, dealers, and fabricators are for reference only and not an exact replication of what will be installed in your home. We advise customers to check the actual slabs to make sure the right colors are received.
23. This warranty does not cover what is referred to as spots or blemishes smaller than 10 mm. A certain level of spots or blemishes are inherent in the manufacturing process and do not affect the structural integrity of the material.
24. PANMINQUARTZ might contain important product information on the back of each slab. Removing this product information will void the warranty.
25. PANMIN is not responsible for damage or injury caused in whole or in part by force majeure, job site conditions, and architectural/engineering design or changes, structural movement/degradation, acts of vandalism, or accidents.

26. PANMIN shall not be responsible in either contract or tort for any loss of direct, indirect, consequential, incidental, special, exemplary, or punitive damages arising out of the use or the inability to use the products covered by this warranty. Some states do not allow exclusion or limitation of incidental damages, so the above limitations or exclusions may not apply to you.

27. This warranty applies only to the purchases of the slab and does not apply to pre-fabricated countertops. Inspect thoroughly the pre-fabricated countertops before fabrication is the sole responsibility of the purchaser. After pre-fabricated countertops have been installed, PANMIN will not acknowledge any claim.

THE FOREGOING IS THE COMPLETE WARRANTY FOR PANMIN AND SUPERSEDES ALL OTHER WARRANTIES AND REPRESENTATIONS, WHETHER ORAL OR WRITTEN.

EXCEPT AS EXPRESSLY SET FORTH ABOVE, NO OTHER WARRANTIES ARE MADE CONCERNING PANMINQUARTZ BY WORDS OR CONDUCT.

PANMIN EXPRESSLY DISCLAIMS ALL WARRANTIES NOT STATED HEREIN, INCLUDING, TO THE EXTENT PERMITTED BY APPLICABLE LAW, ANY WARRANTY THAT MAY EXIST UNDER NATIONAL, STATE, PROVINCIAL OR LOCAL LAW INCLUDING BUT NOT LIMITED TO ANY IMPLIED WARRANTY OF MERCHANTABILITY OR FITNESS FOR A PARTICULAR PURPOSE. SOME LOCATIONS OR OTHER JURISDICTIONS DO NOT ALLOW THE EXCLUSION OF IMPLIED WARRANTIES, SO THE ABOVE LIMITATIONS MAY NOT APPLY TO YOU.

THIS WARRANTY GIVES YOU SPECIFIC LEGAL RIGHTS AND YOU MAY HAVE OTHER RIGHTS WHICH VARY FROM DIFFERENT LOCATION.

THIS WARRANTY CONSTITUTES A PART OF THE SALES CONTRACTS YOU SIGNED.

NOTE: PANMINQUARTZ ® IS THE REGISTERED TRADEMARK OF XIAMEN DEYUAN PANMIN TRADING CO., LTD.

Commercial Limited Warranty

PANMIN warrants that its installed products will be free from manufacturing defects in an interior, commercial use situation for ten (10) years from the date of installation. If a manufacturing defect occurs during the warranty period, this warranty applies exclusively to the repair or replacement of the defective PANMINQUARTZ.

This warranty applies to the repair or replacement of defective material in slab form. PANMIN is not responsible for any other labor costs that could be associated with the repair or replacement of material, including but not limited to the removal, disposal, fabrication, installation, repair, or replacement of collateral items.

No warranty whatsoever is made in regards to materials produced or provided by other manufacturers.

All decisions regarding the existence of manufacturing defects or affecting this warranty shall be made by PANMIN and shall be final and binding on all parties. No representative, dealer, salesperson, distributor, fabricator, or any other person is authorized to make any warranty or promises on behalf of PANMIN.

In the event of a defect covered under this warranty, PANMIN shall have the sole discretion whether to repair or replace the defective material. The cost of installation and/or fabrication is NOT covered under this warranty. Without derogating from the aforementioned, replacement of defective PANMINQUARTZ slab will be subject to inventory constraints. Besides, the replaced slab may not be the same as the defective slab.

Commercial Property is defined as any location open to the general public for business use, private properties subject to residential or commercial rental or lease, or properties designated as hotels, motels, or other temporary residence applications.

This warranty is published officially at www.panmin.com. PANMIN might update the warranty clause at its sole discretion any time. But the specific version of warranty published on the original date of installation is binding upon you and PANMIN.

Terms and Conditions

1. This warranty applies only to PANMINQUARTZ. This warranty does not apply to any other products, including other quartz surfacing products manufactured or supplied by any other party.

2. This warranty applies only to PANMINQUARTZ that have been permanently installed in the interior of a commercial structure and have not been moved or altered from the original installation.
3. This warranty is issued to the ORIGINAL OWNER of the commercial property who purchased and installed PANMINQUARTZ. This warranty expires upon transferring the ownership of the property to subsequent parties. This warranty is not transferable and does not cover claims made by subsequent owners of the commercial properties.
4. This warranty only covers materials that have been paid in full.
5. This warranty does not apply to unoccupied structures.
6. PANMINQUARTZ must be maintained according to PANMINQUARTZ Care & Maintenance Guidelines. The Care & Maintenance guidelines are available at www.panmin.com.
7. This warranty only applies to polished finishes. It does not apply to surfaces with honed and textured finishes.
8. Color samples provided to owner customers, fabricators, and installers may not match the actual stone. PANMINQUARTZ is made of natural quartz. Variation in color, shade, pattern movement, and grain size are quite normal on this natural product. Samples are small pieces cut from a slab; they do not display all the characteristics of the actual slab. These characteristics are inherent in the quartz stone. Color samples provided are for reference only and not an exact replication of what will be installed in your property. We advise customers to check the actual slabs to make sure the right colors are received.
9. If PANMINQUARTZ fail due to a manufacturing defect, PANMIN will, at its sole discretion, repair or replace such materials. PANMIN cannot guarantee an exact color match to an existing product. PANMIN is not liable for any loss of direct or indirect, consequential, incidental, punitive, or any other similar damages arising out of the use or inability to use the product covered by this warranty, including but not limited to loss of use, loss of profits, business interruption, and/or any other losses.
10. Laws and building safety regulations governing the design, engineering, and construction of installations vary widely. PANMIN has no responsibility concerning the selection, design, engineering, or construction of the installation.

11. To obtain service under this commercial warranty, the customer must provide proof of purchase in the form of the sales contract showing the name of the owner of the commercial property. This warranty is not applicable without proof of original contract.

12. Following installation, you must register your product within thirty (30) days to activate your warranty. Complete the online warranty registration form at www.panmin.com. You must agree to cooperate with PANMIN or its authorized agents in the inspection of the product and assist us in efforts to perform our obligations under this warranty.

Exclusions

1. This warranty does not cover PANMINQUARTZ installed in any outdoor places.

2. This warranty does not cover PANMINQUARTZ used as flooring material.

3. This warranty does not cover seam appearance or seam performance, adhesives, caulks, or any other accessory items. Once the product is installed the main reasons for seam separation or cracking are the shifting or movement of the substrate, cabinets, foundation, or thermal shock. Thermal shock can occur when a hot pan, dish, or other receptacle or object is left on the countertop for even a brief period. Trivets or hot pads should always be used. These issues are not considered material defects and are subject to proper care and maintenance by the owner.

4. This warranty does not cover any fabrication work that was not completed by a PANMIN certified fabricator.

5. This warranty does not cover abnormal use or conditions or abuse in any way. Abnormal use or conditions includes, but is not limited to, damage from mishandling or misuse, damage from excessive heat or exposure to weather conditions, exposure to ultraviolet light, physical or chemical abuse, and damage from improper care and maintenance, or failure to follow proper installation practices. Never use paint removers, strong alkaline, acid or oxidizing substances, and products with pumice.

6. This warranty does not cover additional modifications or supplemental repairs such as structural changes, plumbing, electrical installation, cabinets, tiles, etc. that may be necessary to complete the repair or replacement of PANMINQUARTZ covered under this warranty. The supply of these material and labor costs shall be the responsibility of the owner of the commercial property.

7. This warranty does not cover chips, scratches, thermal shock, impact damage, or chemical damages.

PANMINQUARTZ is highly resistant to scratches, but they are not scratching-proof. No cutting shall be done directly on the surface and a cutting board shall always be used. Proper care and maintenance shall be followed at all times – refer to the PANMINQUARTZ Care & Maintenance Guidelines at www.panmin.com.

8. This warranty does not cover mitered edges where the joint is not cut correctly.

9. This warranty does not cover the alteration of any PANMINQUARTZ factory-applied finish. Any issues arising from the practice of “additional and/or in shop honing” are the sole responsibility of the fabricator who performed the process and/or the owner who purchased the original PANMINQUARTZ.

10. This warranty does not cover any abnormal adjustment made to the material including bending, curving, thickness reduction, surface finish variation, or any other alteration to the original PANMINQUARTZ.

11. This warranty does not cover any failures due to inadequate support for the installation. This includes overhangs over recommended support guidelines provided by PANMIN or an unsupported base. Improper fabrication and/or installation is the sole responsibility of the fabricator/installer.

12. This warranty does not cover the installation of sinks, other plumbing fixtures, or appliances.

13. This warranty does not cover a product that has been moved from its original installation location.

14. PANMIN is not responsible for damages or injury caused by force majeure, job site conditions, architectural/engineering design or changes, structural movement/degradation, acts of vandalism, or accidents.

15. PANMINQUARTZ might contain important information on the back of each slab. Removing this product information will void the warranty.

16. This warranty does not cover what is referred to as spots or “beauty marks” smaller than 16mm (5/8 inches). A certain level of spots or “beauty marks” are inherent in the manufacturing process and do not affect the structural integrity of the material.

17. To obtain service under this limited warranty, a PANMINQUARTZ authorized agent must be permitted to inspect the PANMINQUARTZ being claimed. PANMIN requires full cooperation with its agent in the efforts to service this limited warranty. PANMIN’s findings shall be final and binding to all parties.

18. PANMIN makes no other warranty, representation, or guarantee, express or implied, concerning its products, except as expressly stated herein. This is the only warranty offered by PANMIN for its quartz surfacing materials.

19. Other than PANMIN itself, no one is authorized to make any warranty or promise on behalf of PANMIN concerning its materials.

THE FOREGOING IS THE COMPLETE WARRANTY FOR PANMIN AND SUPERSEDES ALL OTHER WARRANTIES AND REPRESENTATIONS, WHETHER ORAL OR WRITTEN.

EXCEPT AS EXPRESSLY SET FORTH ABOVE, NO OTHER WARRANTIES ARE MADE CONCERNING PANMINQUARTZ BY WORDS OR CONDUCT.

PANMIN EXPRESSLY DISCLAIMS ALL WARRANTIES NOT STATED HEREIN, INCLUDING, TO THE EXTENT PERMITTED BY APPLICABLE LAW, ANY WARRANTY THAT MAY EXIST UNDER NATIONAL, STATE, PROVINCIAL OR LOCAL LAW INCLUDING BUT NOT LIMITED TO ANY IMPLIED WARRANTY OF MERCHANTABILITY OR FITNESS FOR A PARTICULAR PURPOSE. SOME LOCATIONS OR OTHER JURISDICTIONS DO NOT ALLOW THE EXCLUSION OF IMPLIED WARRANTIES, SO THE ABOVE LIMITATIONS MAY NOT APPLY TO YOU.

THIS WARRANTY GIVES YOU SPECIFIC LEGAL RIGHTS AND YOU MAY HAVE OTHER RIGHTS WHICH VARY FROM DIFFERENT LOCATION.

THIS WARRANTY CONSTITUTES A PART OF THE SALES CONTRACTS YOU SIGNED.

NOTE: PANMINQUARTZ ® IS THE REGISTERED TRADEMARK OF XIAMEN DEYUAN PANMIN TRADING CO., LTD.

All decisions regarding this warranty are to be made by PANMIN. No distributor, fabricator, installer, or any person is authorized to make any warranty statements and promises regarding PANMINQUARTZ surfacing materials.

PANMIN makes no other warranty, representation, or guarantee, express or implied, with respect to its products, except as expressly stated herein.

Material Safety Data Sheet

1 Identification

Product identifier

Trade name: Quartz Surfaces

Recommended use of the chemical and restrictions on use:

Application of the substance / the preparation: Countertops, Floorings, etc

Details of the supplier of the safety data sheet

Manufacturer/Supplier: PANMINQUARTZ

Full address: RM 2002 No.21 Jiahe Rd Xiamen, Fujian, China

Phone number: +86-592-8065759

Email: info@panmin.com

Other U.S. contact point: Not available

Further information obtainable from: PANMINQUARTZ

Emergency telephone number:

Poison Center

Tel: +1 800 222 1222

2 Hazard(s) identification

Classification of the substance or mixture

Classification according to OSHA Hazard Communication Standard (29 CFR 1910.1200)



GHS08 Health hazard

Carc. 1A H350 May cause cancer.

Repr. 2 H361 Suspected of damaging fertility or the unborn child.

STOT RE 1 H372 Causes damage to the hearing organs through prolonged or repeated exposure.



GHS07

Eye Irrit. 2A H319 Causes serious eye irritation.

Skin Sens. 1 H317 May cause an allergic skin reaction.

Information concerning particular hazards for human and environment:

The product has to be labeled due to the calculation procedure of OSHA Hazard Communication Standard (29 CFR 1910.1200).

Classification system:

The classification is according to the latest edition of OSHA Hazard Communication Standard (29 CFR 1910.1200), and extended by company and literature data.

Label elements**Labelling according to OSHA Hazard Communication Standard (29 CFR 1910.1200)****Hazard pictograms**

GHS07



GHS08

Signal word Danger**Hazard-determining components of labeling:**

Cristobalite

styrene

Tert-butyl 2-ethylperoxyhexanoate

Hazard statements

H319	Causes serious eye irritation.
H317	May cause an allergic skin reaction. H350 May cause cancer.
H361	Suspected of damaging fertility or the unborn child.
H372	Causes damage to the hearing organs through prolonged or repeated exposure.

Precautionary statements

P201	Obtain special instructions before use.
P202	Do not handle until all safety precautions have been read and understood.
P260	Do not breathe dust/fume/gas/mist/vapors/spray.
P264	Wash thoroughly after handling.
P270	Do not eat, drink or smoke when using this product.
P272	Contaminated work clothing must not be allowed out of the workplace.
P280	Wear protective gloves/protective clothing/eye protection/face protection.
P302+P352	If on skin: Wash with plenty of water.
P305+P351+P338	If in eyes: Rinse cautiously with water for several minutes. Remove contact lenses, if present and easy to do. Continue rinsing.
P308+P313	IF exposed or concerned: Get medical advice/attention.

P321	Specific treatment (see on this label).
P314	Get medical advice/attention if you feel unwell.
P333+P313	If skin irritation or rash occurs: Get medical advice/attention.
P337+P313	If eye irritation persists: Get medical advice/attention.
P363	Wash contaminated clothing before reuse.
P405	Store locked up.
P501	Dispose of contents/container in accordance with local/regional/national/international regulations.

Hazards not otherwise classified (HNOC) No further relevant information available.

3 Composition/information on ingredients

Chemical characterization: Mixtures

Description:

Mixture of the substances listed below with nonhazardous additions. For the wording of the listed hazard statements refer to Section 16.

Composition:		
14808-60-7	Quartz	<93%
14464-46-1	Cristobalite Carc. 1A, H350	<50%
68476-25-5	Feldspar Carc. 1A, H350	<50%
100-42-5	Polyster Resin Flam. Liq. 3, H226; Carc. 2, H351; Repr. 2, H361; STOT RE 1, H372; Acute Tox. 4, H332; Skin Irrit. 2, H315; Eye Irrit. 2A, H319	7-15%
60676-86-0	Glass & Mirrors <50%	<50%
13463-67-7	Titanium Dioxide	<5%
2530-85-0	Coupling Agent Flam. Liq. 4, H227	<1%
3006-82-4	Curing Agent Self-react. C, H242; Skin Sens. 1, H317	<1%

4 First-aid measures

Description of first aid measures

General description:

Immediately remove any clothing soiled by the product.

Symptoms of poisoning may even occur after several hours; therefore medical observation for at least 48 hours after the accident.

After inhalation:

Supply fresh air and to be sure call for a doctor.

In case of unconsciousness place patient stably in side position for transportation.

After skin contact: Immediately wash with water and soap and rinse thoroughly.

After eye contact:

Rinse opened eye for several minutes under running water. If symptoms persist, consult a doctor.

After swallowing: If symptoms persist consult doctor.

Most important symptoms and effects, both acute and delayed No further relevant information available.

Indication of any immediate medical attention and special treatment needed

No further relevant information available.

5 Fire-fighting measures

Suitable extinguishing agents:

CO₂, extinguishing powder or water spray. Fight larger fires with water spray or alcohol resistant foam.

Special hazards arising from the substance or mixture:

During heating or in case of fire poisonous gases are produced.

Special protective equipment and precautions for firefighters

Protective equipment: Mouth respiratory protective device.

6 Accidental release measures

Personal precautions, protective equipment and emergency procedures:

Mount respiratory protective device.

Wear protective equipment. Keep unprotected persons away.

Environmental precautions:

Do not allow product to reach sewage system or any water course.

Inform respective authorities in case of seepage into water course or sewage system.

Do not allow to enter sewers/ surface or ground water.

Methods and material for containment and cleaning up:

Dispose contaminated material as waste according to section 13.

Ensure adequate ventilation.

7 Handling and storage

Precautions for safe handling:

Ensure good ventilation/exhaustion at the workplace.

Open and handle receptacle with care.

For the general occupational hygienic measures refer to Section 8.

Information about protection against explosions and fires:

Keep ignition sources away - Do not smoke.

Protect against electrostatic charges.

Keep respiratory protective device available.

Conditions for safe storage, including any incompatibilities

Requirements to be met by storerooms and receptacles: No special requirements.

Information about storage in one common storage facility: Not required.

Further information about storage conditions: Keep receptacle tightly sealed.

8 Exposure controls/personal protection

Components with limit values that require monitoring at the workplace:

14808-60-7 Quartz (<93%)		
PEL (USA)	Long-term value: 0.05* mg/m ³	*resp. dust; 30mg/m ³ /%SiO ₂ +2
REL (USA)	Long-term value: 0.05* mg/m ³	*respirable dust; See Pocket Guide App. A
TLV (USA)	Long-term value: 0.025* mg/m ³	*as respirable fraction
14464-46-1 Cristobalite (<50%)		
PEL (USA)	Long-term value: 0.05* mg/m ³	*resp. dust; ½ value from resp.dust formulae Quartz
REL (USA)	Long-term value: 0.05* mg/m ³	*respirable dust; See Pocket Guide App. A
TLV (USA)	Long-term value: 0.025* mg/m ³	*as respirable fraction
100-42-5 Polyester Resin(7-15%)		
PEL (USA)	Long-term value: 100 ppm	Ceiling limit value: 200; 600* ppm *5-min peak in any 3 hrs
REL (USA)	Short-term value: 425 mg/m ³ , 100 ppm	Long-term value: 215 mg/m ³ , 50 ppm
TLV (USA)	Short-term value: 20 ppm	Long-term value: 10 ppm BEI, OTO

60676-86-0 Glass & Mirrors(<50%)	
PEL (USA)	20mppcf or 80mg/m3 /%SiO2
TLV (USA)	TLV withdrawn
13463-67-7 Titanium Dioxide (<5%)	
PEL (USA)	Long-term value: 15* mg/m ³ *total dust
REL (USA)	See Pocket Guide App. A
TLV (USA)	Long-term value: 10 mg/m ³

Regulatory information

PEL (USA): Guide to Occupational Exposure Values (OSHA PELs)

REL (USA): Guide to Occupational Exposure Values (NIOSH RELs)

TLV (USA): Guide to Occupational Exposure Values (ACGIH)

Ingredients with biological limit values:

100-42-5 Polyester Resin	
BEI (USA)	<p>400 mg/g creatinine Medium: urine Time: end of shift Parameter: Mandelic acid plus phenylglyoxylic acid (nonspecific)</p> <p>0.2 mg/L Medium: venous blood Time: end of shift Parameter: Styrene (semi-quantitative)</p>

Additional information: The lists that were valid during the creation were used as basis.

Based on the composition shown in Section 3, the following measures are suggested for occupational safety measure.

Appropriate engineering controls:

- Keep away from foodstuffs, beverages and feed.
- Immediately remove all soiled and contaminated clothing.
- Wash hands before breaks and at the end of work.

Store protective clothing separately.

Avoid contact with the eyes.

Avoid contact with the eyes and skin.

See Section 7 for information about design of technical facilities.

Personal protective equipment:

Breathing equipment:

In case of brief exposure or low pollution use respiratory filter device. In case of intensive or longer exposure use respiratory protective device that is independent of circulating air.

Protection of hands:



Protective gloves

The glove material has to be impermeable and resistant to the product/ the substance/ the preparation.

Due to missing tests no recommendation to the glove material can be given for the product/ the preparation/ the chemical mixture.

Selection of the glove material on consideration of the penetration times, rates of diffusion and the degradation

Material of gloves

The selection of the suitable gloves does not only depend on the material, but also on further marks of quality and varies from manufacturer to manufacturer. As the product is a preparation of several substances, the resistance of the glove material can not be calculated in advance and has therefore to be checked prior to the application.

Penetration time of glove material:

The exact break through time has to be found out by the manufacturer of the protective gloves and has to be observed.

Eye protection:



Tightly sealed goggles

9 Physical and chemical properties

General Information Appearance: Form: Color: Odor: Odor threshold:	Solid According to product specification Odourless Not available
pH-value:	Not available
Change in condition Melting point/Freezing point: Initial boiling point and boiling range:	Not available Not available
Flash point:	Not available
Flammability (solid, gaseous):	Not available
Auto-ignition temperature:	Not available
Decomposition temperature:	Not available
Explosion limits: Lower: Upper:	Not available Not available
Vapor pressure:	Not available
Density: Relative density: Vapor density: Evaporation rate:	Not available Not available Not available Not available
Solubility in / Miscibility with Water:	Not available
Partition coefficient (n-octanol/water):	Not available
Viscosity: Dynamic: Kinematic:	Not available Not available
Other information	No further relevant information available.

10 Stability and reactivity

Reactivity: Data not available

Chemical stability: Data not available

Possibility of hazardous reactions: No dangerous reactions known.

Conditions to avoid: No further relevant information available.

Incompatible materials: No further relevant information available.

Hazardous decomposition products: No dangerous decomposition products known.

11 Toxicological information

Acute toxicity:

LD/LC50 values that are relevant for classification:		
100-42-5 Polyester Resin		
Oral	LD50	5,000 mg/kg (rat)
13463-67-7 Titanium Dioxide		
Oral	LD50	>20,000 mg/kg (rat)
Dermal	LD50	>10,000 mg/kg (rabbit)
Inhalative	LC50/4 h	>6.82 mg/l (rat)

Skin corrosion/irritation: Irritating effect possible.

Serious eye damage/irritation: Irritating effect.

Respiratory or skin sensitization: Sensitization possible through skin contact.

Additional toxicological information:

The product shows the following dangers according to internally approved calculation methods for preparations:

Harmful

Irritant

Carcinogenic categories

IARC (International Agency for Research on Cancer)		
14808-60-7	Quartz	1
114464-46-1	Cristobalite	1

100-42-5	Polyster Resin	2B
60676-86-0	Glass & Mirrors	3
13463-67-7	Titanium Dioxide	2B
100-42-5	Polyster Resin	2B
NTP (National Toxicology Program)		
14808-60-7	Quartz	K
14464-46-1	Cristobalite	K
100-42-5	Polyster Resin	R
OSHA-Ca (Occupational Safety & Health Administration)		
None of the ingredients is listed.		

12 Ecological information

Toxicity

Aquatic toxicity: No further relevant information available.

Persistence and degradability: No further relevant information available.

Bioaccumulative potential: No further relevant information available.

Mobility in soil: No further relevant information available.

Other adverse effects No further relevant information available.

13 Disposal considerations

Waste treatment methods

Recommendation:

Must not be disposed of together with household garbage. Do not allow product to reach sewage system.

Uncleaned packagings:

Recommendation: Disposal must be made according to official regulations.

Recommended cleansing agent: Water, if necessary with cleansing agents.

14 Transport information

UN-Number DOT, IMDG, IATA	Not applicable
UN proper shipping name DOT, IMDG, IATA	Not applicable
Transport hazard class(es) DOT, IMDG, IATA Class Label	Not applicable
Packing group DOT, IMDG, IATA	Not applicable
Environmental hazards: Marine pollutant:	No
Special precautions for user	Not applicable
Transport in bulk according to Annex II of MARPOL73/78 and the IBC Code	Not applicable
UN "Model Regulation":	Void

15 Regulatory information

Safety, health and environmental regulations/legislation specific for the substance or mixture

Sara

Section 355 (extremely hazardous substances):	None of the ingredients is listed.
Section 313 (Specific toxic chemical listings):	100-42-5 Polyster Resin
TSCA (Toxic Substances Control Act):	All components have the value ACTIVE.

Proposition 65

Chemicals known to cause cancer:		
14808-60-7 14464-46-1 100-42-5 13463-67-7	Quartz Cristobalite Polyster Resin Titanium Dioxide	
Chemicals known to cause reproductive toxicity for females:		None of the ingredients is listed.
Chemicals known to cause reproductive toxicity for males:		None of the ingredients is listed.
Chemicals known to cause developmental toxicity:		None of the ingredients is listed.
New Jersey Right-to-Know List:		
14808-60-7 14464-46-1 100-42-5 60676-86-0 13463-67-7	Quartz Cristobalite Polyster Resin Glass & Mirrors Titanium Dioxide	
New Jersey Special Hazardous Substance List:		
14808-60-7 14464-46-1 100-42-5	Quartz Cristobalite Polyster Resin	CA CA CA, F3, R2
Pennsylvania Right-to-Know List:		
14808-60-7 14464-46-1 100-42-5 13463-67-7	Quartz Cristobalite Polyster Resin Titanium Dioxide	
Pennsylvania Special Hazardous Substance List:		
14808-60-7 14464-46-1 100-42-5 13463-67-7	Quartz Cristobalite Polyster Resin Titanium Dioxide	
Pennsylvania Special Hazardous Substance List:		
100-42-5	Polyster Resin	E

Cancerogenity categories

EPA (Environmental Protection Agency)		None of the ingredients is listed.
TLV (Threshold Limit Value established by ACGIH)		
14808-60-7	Quartz	A2
14464-46-1	Cristobalite	A2
100-42-5	Polyster Resin	A4
13463-67-7	Titanium Dioxide	A4
NIOSH-Ca (National Institute for Occupational Safety and Health)		
14808-60-7	Quartz	
14464-46-1	Cristobalite	
13463-67-7	Titanium Dioxide	

16 Other information

Relevant hazard statements

- H226 Flammable liquid and vapor. H227 Combustible liquid.
- H242 Heating may cause a fire. H315 Causes skin irritation.
- H317 May cause an allergic skin reaction. H319 Causes serious eye irritation.
- H332 Harmful if inhaled.
- H335 May cause respiratory irritation. H350 May cause cancer.
- H351 Suspected of causing cancer.
- H361 Suspected of damaging fertility or the unborn child.
- H372 Causes damage to the hearing organs through prolonged or repeated exposure.

DISCLAIMER OF LIABILITY

The information contained herein was obtained from sources which we believe are reliable. However, the information is provided without any warranty, express or implied, regarding its correctness. The conditions or methods of handling, storage, use or disposal of the product are beyond our control and may be beyond our knowledge. For this and other reasons, we do not assume responsibility and expressly disclaim liability for loss, damage or expense arising out of or in any way connected with the handling, storage, use or disposal of the product. In addition, the contents of this Safety Data Sheet must not be interpreted as a recommendation to use any product in violation of the laws, safety practices or patents in force on any material or its use. It is the responsibility of the recipient of our product to check the corresponding rules and regulations. Under no circumstances does the data

contained in this Safety Data Sheet constitute a guarantee of specific properties or create any contractual relationship. This version is based on the format for the United States. Contact your local authority if an emergency occurs.

Abbreviations and acronyms:

IMDG: International Maritime Code for Dangerous Goods

DOT: US Department of Transportation

IATA: International Air Transport Association

ACGIH: American Conference of Governmental Industrial Hygienists

EINECS: European Inventory of Existing Commercial Chemical Substances

ELINCS: European List of Notified Chemical Substances

CAS: Chemical Abstracts Service (division of the American Chemical Society)

LC50: Lethal concentration, 50 percent

LD50: Lethal dose, 50 percent

NIOSH: National Institute for Occupational Safety

OSHA: Occupational Safety & Health

Flam. Liq. 3: Flammable liquids – Category 3

Flam. Liq. 4: Flammable liquids – Category 4

Self-react. C: Self-reactive substances and mixtures – Type C/D

Acute Tox. 4: Acute toxicity – Category 4

Skin Irrit. 2: Skin corrosion/irritation – Category 2

Eye Irrit. 2A: Serious eye damage/eye irritation – Category 2A

Skin Sens. 1: Skin sensitisation – Category 1

Carc. 1A: Carcinogenicity – Category 1A

Carc. 2: Carcinogenicity – Category 2

Repr. 2: Reproductive toxicity – Category 2

STOT SE 3: Specific target organ toxicity (single exposure) – Category 3

STOT RE 1: Specific target organ toxicity (repeated exposure) – Category 1

Receipt Form

Please complete this page and return it to:

Xiamen Deyuan Panmin Trading Co., Ltd.

Room 2002, No.21 Jiahe Road, Siming District, Xiamen City, Fujian Province, China

Receipt Form

The undersigned acknowledges receipt of the PANMINQUARTZ Product Manual.

Fabricator's Business Details:

Company Name: _____

Address: _____

Country: _____

Telephone Number: _____

Name: _____

Signature: _____

Date: _____

Please read through the PANMINQUARTZ product manual carefully. You should carefully comply with all applicable local laws and regulations. We also commend that you consult with your local occupational health professional and other advisors on the applicable laws, regulations and recommended protection measures.



PMC1633

PANMINQUARTZ

PANMINQUARTZ[®]

Xiamen Deyuan Panmin Trading Co., Ltd.
Room 2002, No.21 Jiahe Road, Siming District,
Xiamen City, Fujian Province, China

www.panmin.com
info@panmin.com

© Copyright PANMIN 2021.
PANMINQUARTZ[®] is the registered trademark of
Xiamen Deyuan Panmin Trading Co., Ltd.